



CAPITAL 300



DESCRIPTION

Featuring an elegant, stylish design and a sleek profile, which allow a seamless integration in every architectural environment, CAPITAL 300 is the ideal solution for the dramatic illumination of large-scale façades and high-rise buildings calling for high impact lighting. With an industry leading high lumen package, this luminaire effectively achieves desired goals, ranging from wall washing applications to architectural elements distinctive enhancement. Alternative ON-OFF white light versions available.

MAIN FEATURES

- Max. delivered lm output: 27930 lm / 98 lm/W
- Size: (HxWxD) 383x492x105 mm / 15x19.4x4.1"
- Control system: DMX-RDM, DALI DT8, DALI, ON-OFF, 0-10V, on-board or remote wireless data
- Powerful floodlight specific for dramatic wall wash effects on large scale façades and high-rise buildings

LED COLOUR CONFIGURATIONS



CAPITAL 300

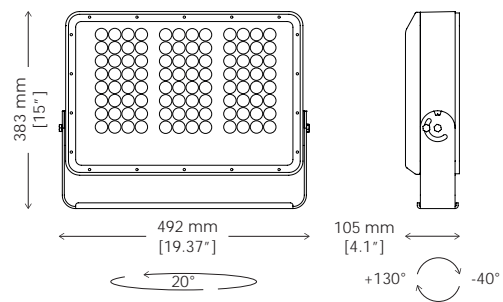

FEATURES

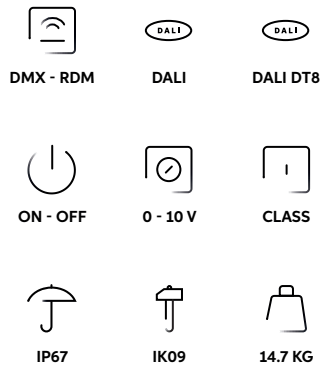

LED COLOUR CONFIGURATIONS



OPTIONS

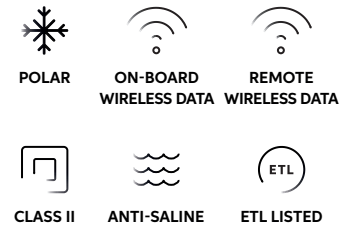

FINISHES

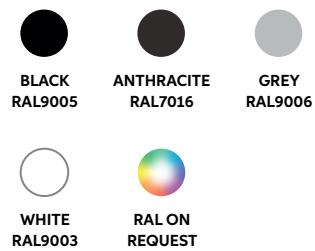

MORE INFO



CODES

AL5014 CAPITAL 300
AL5015 CAPITAL 300 POLAR EDITION
AL5034 CAPITAL 300 B

PERFORMANCE	WATT	MAX LM OUTPUT	LM/WATT
CAPITAL 300 RGBW	256	16201	63
CAPITAL 300 DW	285	27930	98
CAPITAL 300 W	285	27814	98
CAPITAL 300 B	220	21470	98

BEAM ANGLE REFERENCE	RGBW	DW/W
SPOT	8°	12°
NARROW	12°	15°
MEDIUM	23°	25°
WIDE	44°	48°
EXTRA WIDE	59°	66°
ELLIPTICAL	9° x 42°	14° x 39°
ELLIPTICAL WIDE	19° x 39°	22° x 37°
WALL WASH	14° (5° incline) x 37°	19° (5° incline) x 37°



South Korea – Ourhome H.Q., Seoul